

SPECIFICATIONS

Max. operating pressure	207 BAR (3000 PSI)
Max. flow capacity	70 LPM (20 GPM)

SYMBOLS

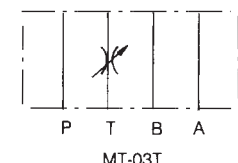
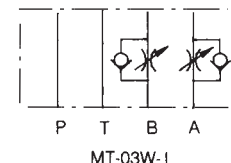
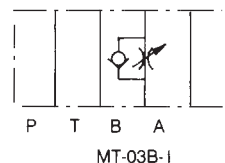
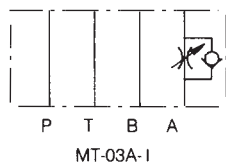
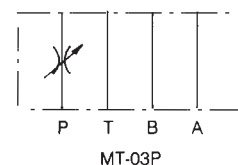
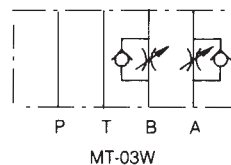
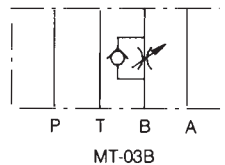
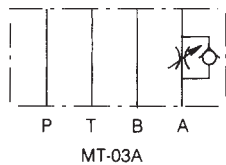

HOW TO ORDER

MT - 03W - K - I - 40

DESIGN NUMBER

CONTROLLED MODEL:
I : METER IN
NO CODE : METER OUT

ADJUSTMENT MODEL :
K : WITH KNOB
NO CODE : WITHOUT KNOB

FUNCTION PORT :
P : P PORT
T : T PORT
A : A PORT
B : B PORT
W : A&B PORT

PORT SIZE : 3/8" (D05)

MODULAR THROTTLE AND CHECK VALVE

MT-03 SERIES

PERFORMANCE CURVES

Models with MT-03W/A/B

Viscosity: 35 cSt (175 SSU)

Temperature: 50°C (122° F)

PRESSURE DROP

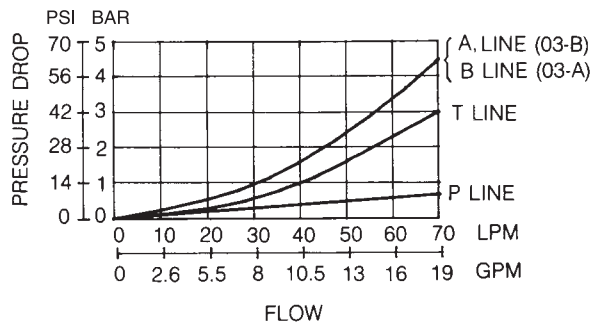

METERED FLOW VS. DIAL POSITION

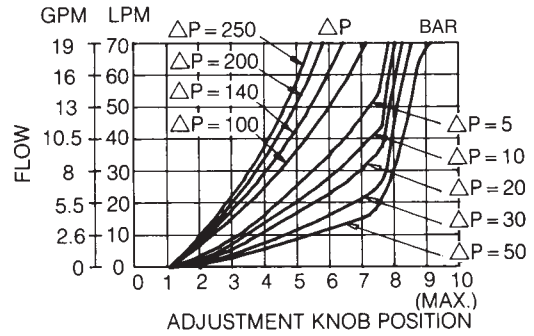

PRESSURE DROP FOR FREE FLOW

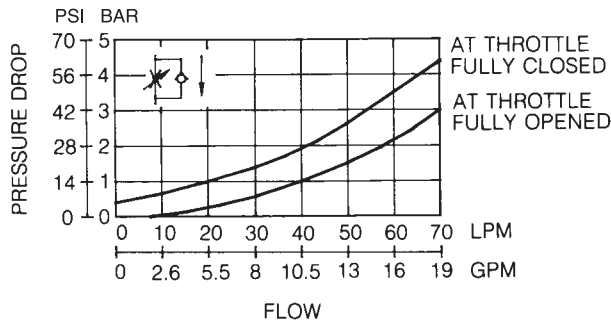

PRESSURE DROP AT THROTTLE FULLY OPENED

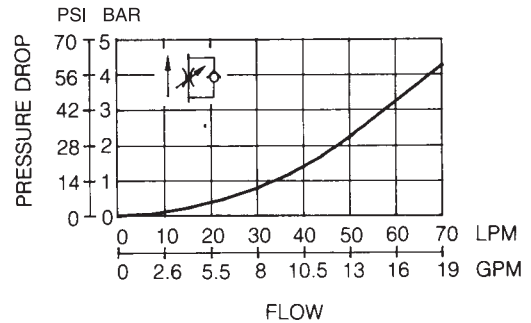

INSTALLATION DIMENSIONS

Models with MT-P/T

Viscosity: 35 cSt (175 SSU)

Temperature: 50°C (122° F)

PRESSURE DROP

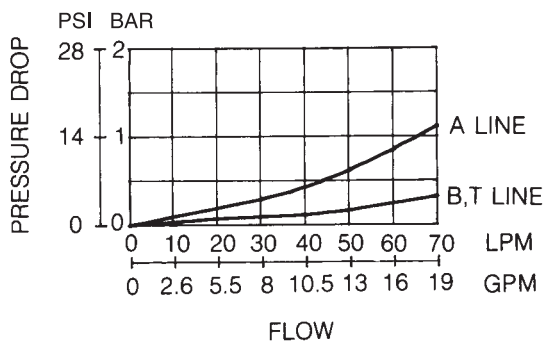

METERED FLOW VS. DIAL POSITION

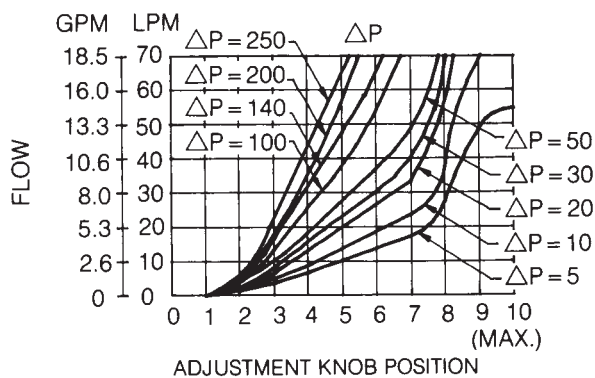

PRESSURE DROP AT THROTTLE FULLY OPENED

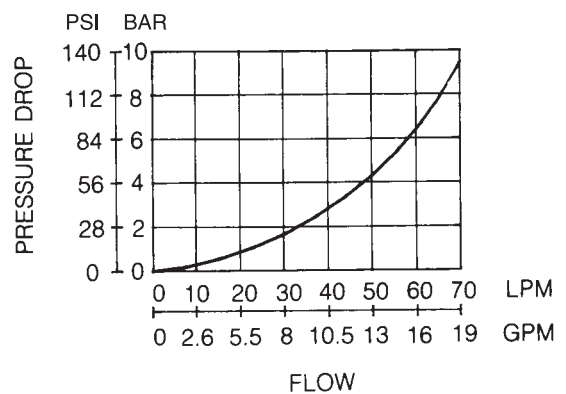

MT-03 SERIES

INSTALLATION DIMENSIONS

UNIT: mm(inch)
WEIGHT: 2.8 kgs(6.171 lbs)

MT - 03W - ※ - ※ - 40

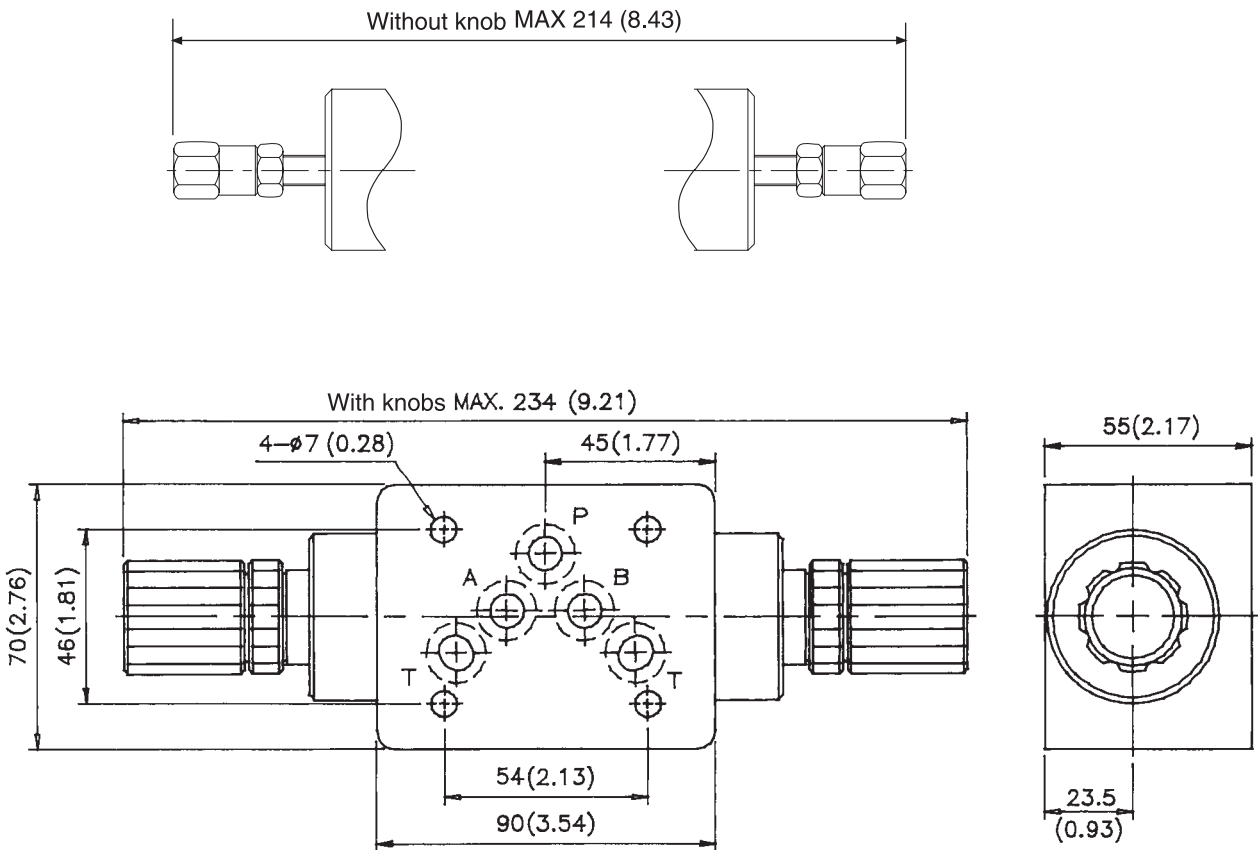

INSTALLATION DIMENSIONS

UNIT: mm(inch)
 WEIGHT: 2.4 kgs(5.29 lbs)
 Mounting Surface: ISO 4401-AB-03-4-A

MT - 03A - ※ - ※ - 40

Without knob MAX 170 (6.70)

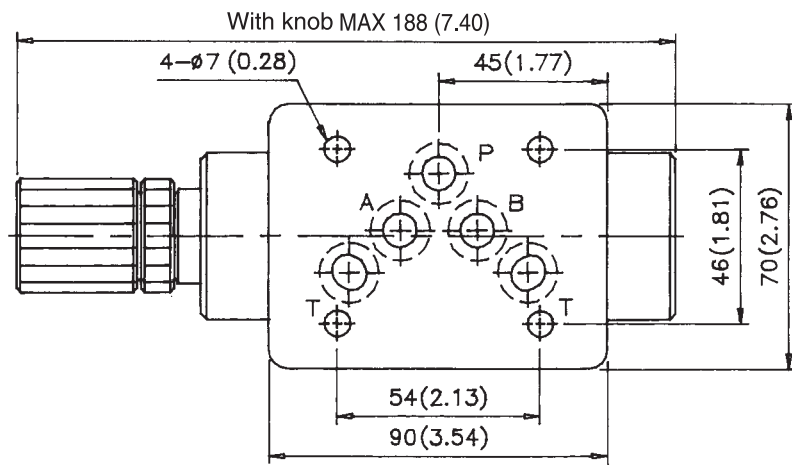
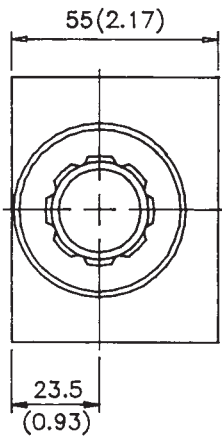
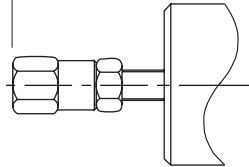

MT-03 SERIES

INSTALLATION DIMENSIONS

UNIT: mm(inch)
WEIGHT: 2.4 kgs(5.29 lbs)
Mounting Surface: ISO 4401-AB-03-4-A

MT - 03B - ※ - ※ - 40

